

Electro-Voice®
a gulton company

Model HT94 Constant-Directivity Horn

SPECIFICATIONS

The following specifications are in accordance with or exceed the "AES Draft Recommended Practice for Specification of Loudspeaker Components used in Professional Sound Reinforcement Systems - 1983".

Horizontal Beamwidth:

90° (+10°, -15°)
(-6 dB, average 3 kHz to 16 kHz)

Vertical Beamwidth:

40° (+17°, -0°)
(-6 dB, average 3 kHz to 16 kHz)

Directivity Factor R_0 (Q):

12.9 (+3.4, -3.4)
average 3 kHz to 16 kHz

Directivity Index D_1 :

11.0 dB (+1.1, -1.2 dB)
(10 log R_0 , average 3 kHz to 16 kHz)

Usable Lower Frequency Limit:

1500 Hz

Recommended Minimum (-3 dB)

Crossover Frequency for Constant Directivity:
3000 Hz

Construction:

Diecast aluminum

Mechanical Connection:

Screw-on, a standard 1-3/8" - 18 thread allows the attachment of the DH2305 driver and any other standard screw thread driver.

Recommended Drivers:

DH2305
DH1506

Dimensions:

24.1 cm (9.5 in.)
19.5 cm (7.7 in.)
14.7 cm (5.8)

Weight:

0.5 kg (1.1 lb)

Shipping Weight:

0.7 kg (1.5 lb)

DESCRIPTION

The Electro-Voice HT94 is a rigid, die cast, wide-angle high-frequency horn that provides precise pattern control over the frequency range from 3 kHz to 16 kHz. The results of the latest research into theoretical horn behavior by Electro-Voice engineers is incorporated in its design.

Its size and the expansion of its walls are optimized to load the driver (DH2305 or other screw-thread mount unit) smoothly to 1500 Hz, such as normally expected from an exponential horn of similar size. While providing excellent vertical and horizontal pattern control, this horn does not exhibit a strongly reactive response in the cutoff region, as would normally be expected from this class of "CD" horn design.

R_0 and D_1 vs Frequency
(one-third octave bandwidths)

Freq. (Hz)	R_0	D_1 (dB)	Freq. (Hz)	R_0	D_1 (dB)
1.6 k	9.9	10.0	6.3 k	10.2	10.1
2.0 k	12.3	10.9	8.0 k	9.5	9.8
2.5 k	14.1	11.5	10.0 k	9.6	9.8
3.1 k	13.1	11.2	12.5 k	13.3	11.2
4.0 k	11.9	10.8	16.0 k	16.3	12.1
5.0 k	10.5	10.2			

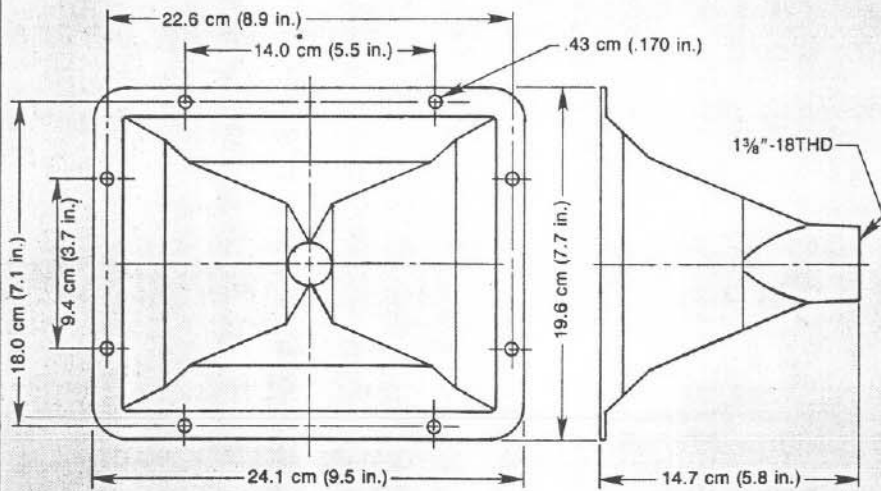

FIGURE 1
Dimensions

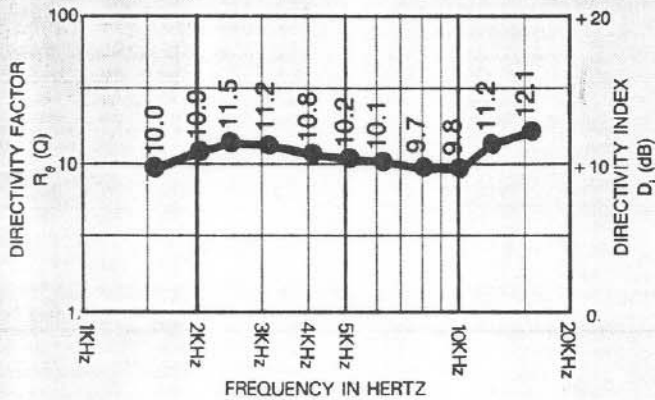

FIGURE 2
Directivity vs Frequency — HT94
Whole Space (Anechoic)

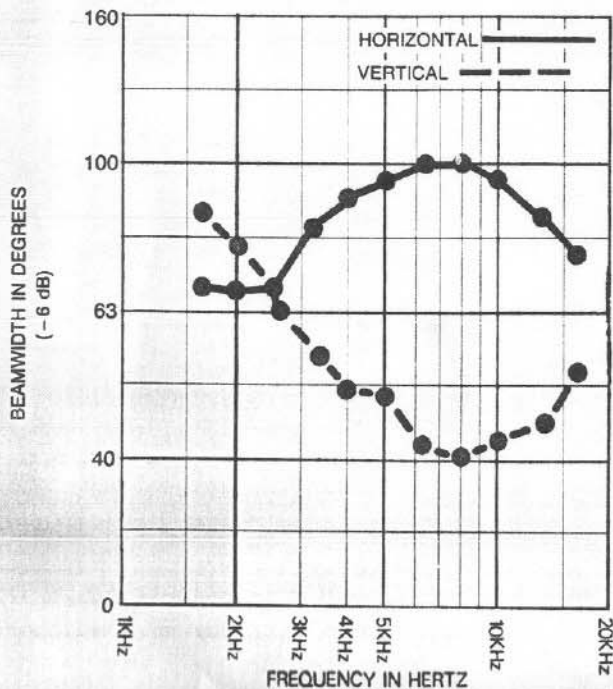

FIGURE 3
Beamwidth vs Frequency — HT94
Whole Space (Anechoic)

DIRECTIVITY

The axial directivity factor P_θ (formerly Q) of the HT94 horn was computed at each one-third octave center frequency from the horizontal/vertical polars which are displayed on the left. The graph in Figure 2 illustrates this data over the range 1-5 kHz to 16 kHz. This axial frequency response of the HT94 horn with a particular driver is in close correspondence to that driver's power response above 1 kHz.

BEAMWIDTH

A plot of the HT94's 6-dB-down total included beamwidth angle is shown in Figure 3 for each one-third octave center frequency. The horizontal beamwidth is maintained at 90° ($+10^\circ -15^\circ$) over the range 3 kHz to 16 kHz. Vertical beamwidth control occurs only above 3 kHz because of the relatively short vertical dimension of the horn's mouth.

POLAR RESPONSE

The directional characteristics of the HT94 with driver attached were measured by running a set of horizontal/vertical polar responses, in EV's large anechoic chamber, at each one-third octave center frequency. The test signal was one-third octave bandwidth limited pseudo-random pink noise (1.0 Hz repetition rate) centered at the indicated frequencies. The measurement microphone was placed 6-1 m (20 ft.) from the horn mouth, while rotation was about the horn rear driver flange. The horn was suspended freely with no baffle. The polars shown in Figure 8 display the results of these tests. The center frequency and beamwidth angle are noted on each polar. The top angle at the center on each chart is the horizontal beamwidth (—) and the bottom angle is the vertical beamwidth(---).

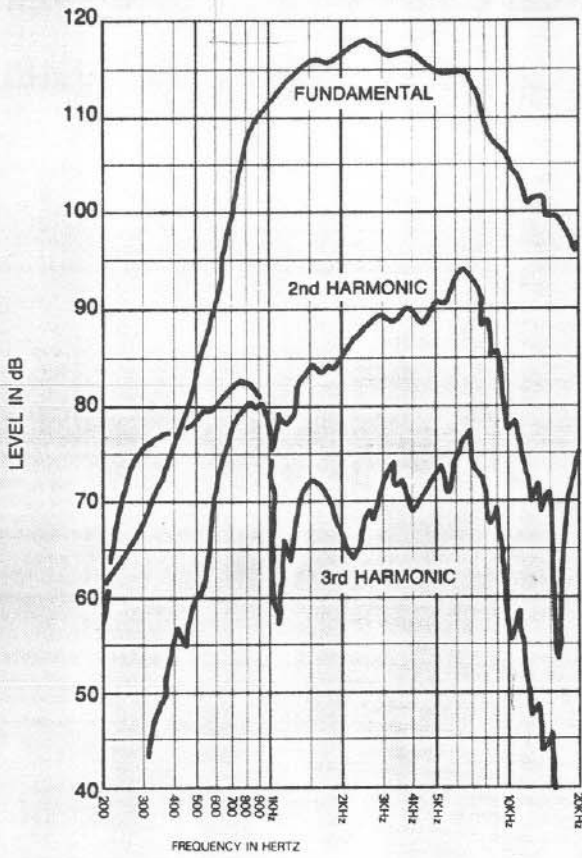

FIGURE 4
Distortion Response — DH2305 Driver on HT94 Horn
(2 Watts/1 Meter)

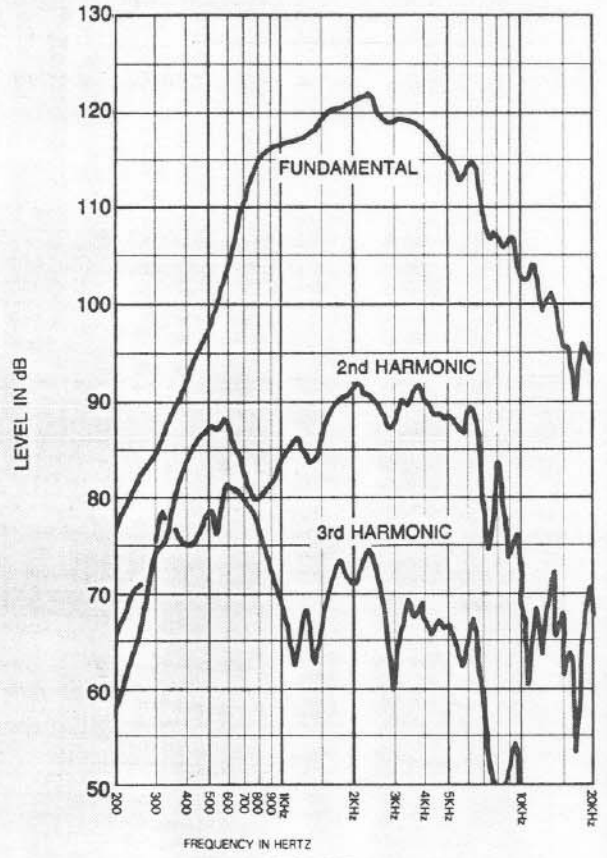

FIGURE 5
Distortion Response — DH1506 Driver on HT94 Horn
(2 Watts/1 Meter)

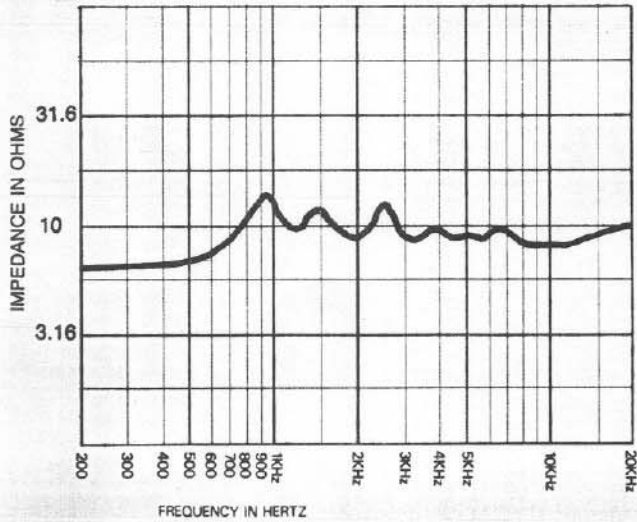

FIGURE 6
Impedance Response — DH2305 on HT94 Horn

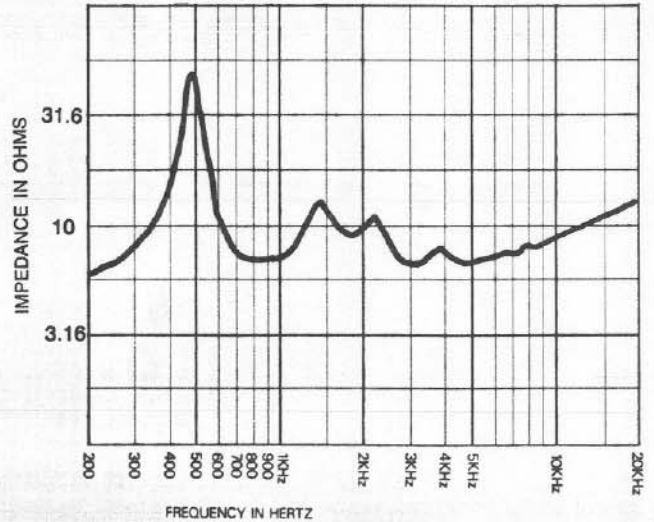

FIGURE 7
Impedance Response — DH1506 on HT94 Horn

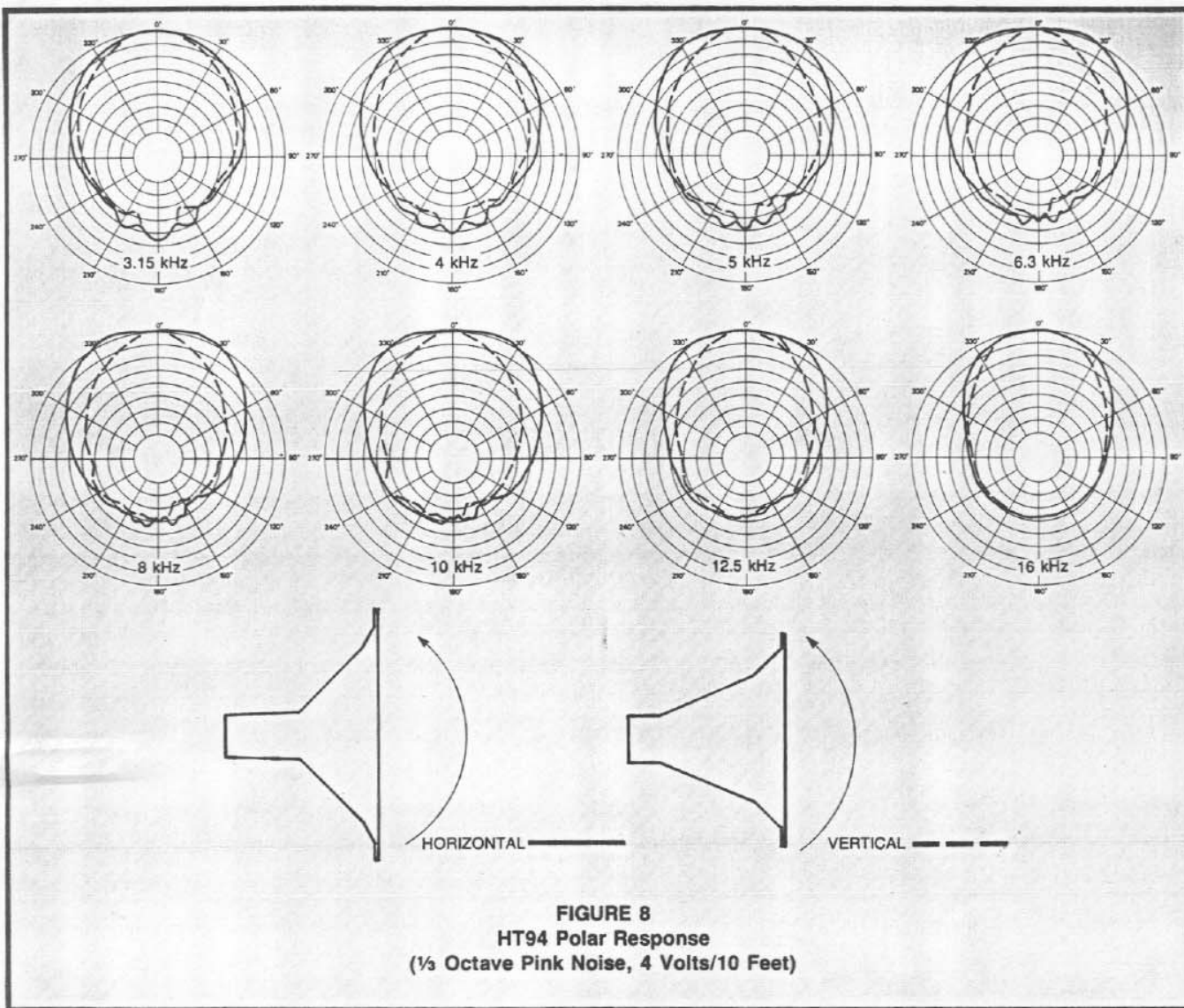

FIGURE 8
HT94 Polar Response
($\frac{1}{3}$ Octave Pink Noise, 4 Volts/10 Feet)

WARRANTY (Limited) —

Electro-Voice Professional Sound Reinforcement Loudspeakers and Accessories are guaranteed for five years from date of original purchase against malfunction due to defects in workmanship and materials. If such malfunction occurs, unit will be repaired or replaced (at our option) without charge for materials or labor if delivered prepaid to the proper Electro-Voice service facility. Unit will be returned prepaid. Warranty does not cover finish or appearance items or malfunction due to abuse or operation at other than specified conditions. Repair by other than Electro-Voice or its authorized service agencies will void this guarantee.

For shipping address and instructions on return of Electro-Voice products for repair and locations of authorized service agencies, please write: Service Department, Electro-Voice, Inc., 600 Cecil Street, Buchanan, Michigan 49107 (Phone: 616/695-6831) or Electro-Voice West, 8234 Doe Ave., P.O. Box 3297, Visalia, California 93277 (Phone: 209/625-1330-1).

Electro-Voice also maintains complete facilities for non-warranty service.

Service and repair address for this product: Electro-Voice, Inc., 600 Cecil Street, P.O. Box 186, Buchanan, Michigan 49107.

Specifications subject to change without notice.



ELECTRO-VOICE, INC., 600 Cecil Street, Buchanan, Michigan 49107

MANUFACTURING PLANTS AT ■ BUCHANAN, MI ■ NEWPORT, TN ■ SEVIERVILLE, TN ■ REDMOND, WA ■ GANANOQUE, ONT.
 ©Gulton Industries, Inc. 1984 ■ Litho In U.S.A. Part Number 530451-433